

- MATERIALS:**
1. Housing: PBT (UL 94V-0), Green
 2. Bracket: PBT/PA66/LCP (UL 94V-0), Black
 3. Contacts: Brass
 4. Shell: SPCC
 5. Rivet: Copper Alloy(Lead \leq 40000PPM)
 6. Board Lock: SPCC
 7. Screw: SPCC
- Or Copper Alloy(Lead \leq 40000PPM)

- FINISH:**
1. Contacts: Gold Flash Plated on Contact Area
Tin Plated on Solderails
Nickel Under Plated Over All
 2. Shell: Nickel Plated
 3. Rivet: Nickel Plated
 4. Board Lock: Tin Plated
 5. Screw: Nickel Plated

- SPECIFICATION:**
1. Current Rating: 2 Amp
 2. Dielectric Withstanding Voltage: AC 500V For 1 minute
 3. Insulation Resistance: 5000M Ω Min
 4. Contact Resistance: 30m Ω Max.
 5. Operating Temperature: -55°C to +105°C

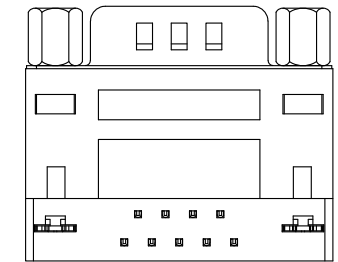
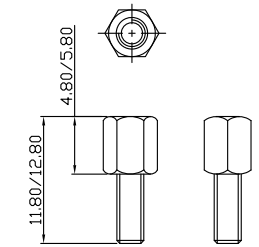
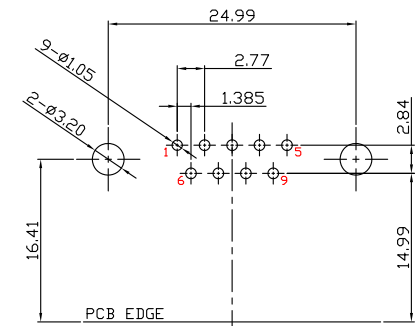
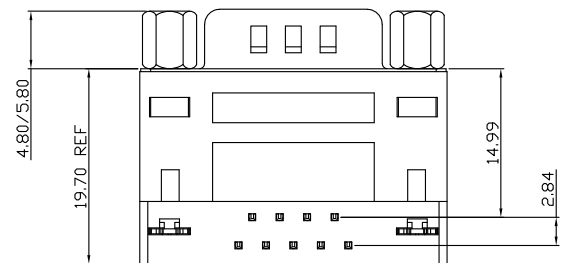

鉚合鎖螺絲型

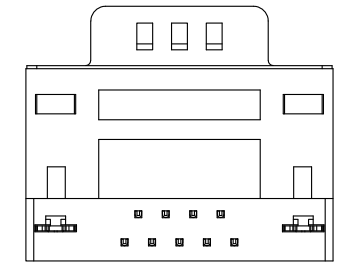

鉚合型

僅供參考

XIAN YI PRECISION CO., LTD.
祥益精密股份有限公司

TITLE / 品名: D-Sub 二排 9P 公座 90度 架高型 DIP Type

PART NO / 料號: D32122-09M-Rxxxx

核準發行章

APPROVE / 核準	CHECKED / 審查	DRAWING / 繪圖	DRAWING NO / 圖號	UNIT / 單位	☉	X
<i>Kin</i>	<i>Chenrong</i>	<i>Chenrong</i>	A-0D-013-00	mm	SHEET 1 OF 1	

NO.	REV / 版本	圖面僅供參考, 實際尺寸以承認圖為主	2025/12/19
		修訂內容	日期

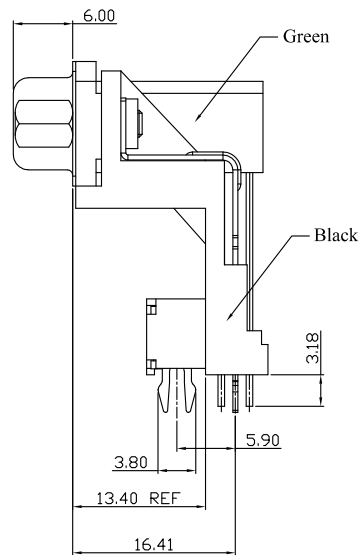
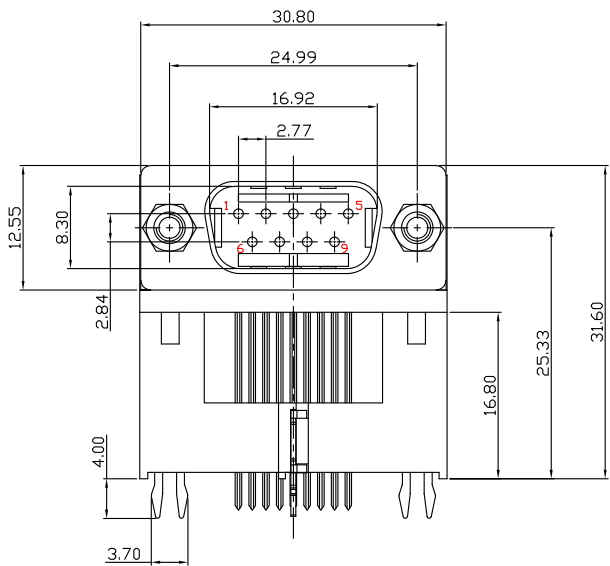

- MATERIALS:**
- Housing: PBT (UL 94V-0), Green
 - Bracket: PBT/PA66/LCP (UL 94V-0), Black
 - Contacts: Brass
 - Shell: SPCC
 - Rivet: Copper Alloy(Lead \leq 40000PPM)
 - Board Lock: SPCC
 - Screw: SPCC
- Or Copper Alloy(Lead \leq 40000PPM)

- FINISH:**
- Contacts: Gold Flash Plated on Contact Area
Tin Plated on Solderails
Nickel Under Plated Over All
 - Shell: Nickel Plated
 - Rivet: Nickel Plated
 - Board Lock: Tin Plated
 - Screw: Nickel Plated

- SPECIFICATION:**
- Current Rating: 2 Amp
 - Dielectric Withstanding Voltage: AC 500V For 1 minute
 - Insulation Resistance: 5000M Ω Min
 - Contact Resistance: 30m Ω Max.
 - Operating Temperature: -55°C to +105°C

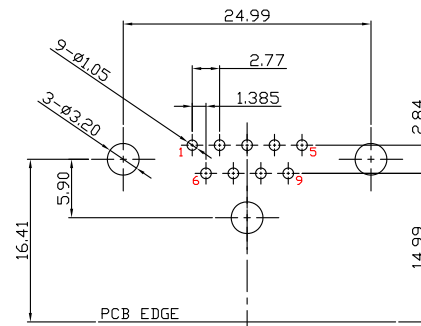
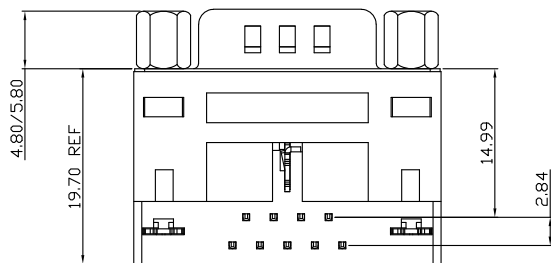
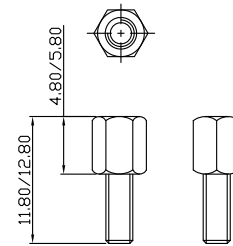

P.C.B. LAYOUT

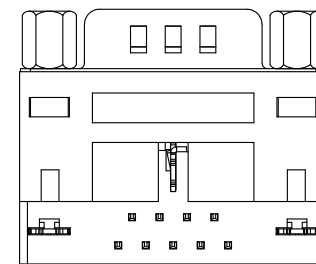

鉚合鎖螺絲型

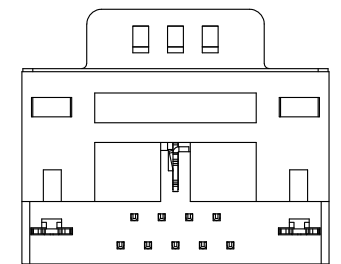

鉚合型

僅供參考

XIAN YI PRECISION CO., LTD.
祥益精密股份有限公司

TITLE / 品名: D-Sub 二排 9P 公座 90度 架高型 DIP Type

PART NO / 料號: D32322-09M-Rxxxx

核準發行章

APPROVE / 核準	CHECKED / 審查	DRAWING / 繪圖	DRAWING NO / 圖號	UNIT / 單位	☉	X
<i>Kin</i>	<i>Chenrong</i>	<i>Chenrong</i>	A-0D-011-00	mm	SHEET 1 OF 1	

NO.	REV / 版本	圖面僅供參考, 實際尺寸以承認圖為主	2025/12/19
		修訂內容	日期